

# FT-1000

HF ALL MODE TRANSCEIVER

 **YAESU**  
Choice of the World's top DX'ers™



*The Best  
of the  
Best*

# FOOD CALL CEIVER TRANS

Extensive Design and Development Effort or  
nent itech experts all competitive performance  
pro existing capabilities. With the 1000 is the  
Synthesizer to be distributed in the form of  
integrated test equipment a software develop-  
interfaced with the application of the engi-  
featuring digital and optimized technologies  
series to applications demanding needs  
on the hf bands.





**OH2BH Martti Laine**

The FT-1000's dual receive design allows frequency, mode and filter diversity reception, plus antenna diversity reception with the BPF-1 option.

### QRM Rejection Systems

A tunable ( $\pm 1.2$  kHz) notch filter in the 100-kHz 4th IF provides more than 40 dB rejection of unwanted heterodynes or CW signals in all modes (except FM). A sharp 4-pole tunable audio peak filter allows comfortable separation of CW signals in crowded bands. IF shift provides fine adjustment of the filter center frequency up to  $\pm 1.12$ -kHz on the IF passband, and single-control IF width allows narrowing the actual IF passband without affecting the center frequency. Separate wide and narrow pulse noise blanker circuits can be selected independently for both "woodpecker" and switching transient noise suppression.

### Shift/Width Controls

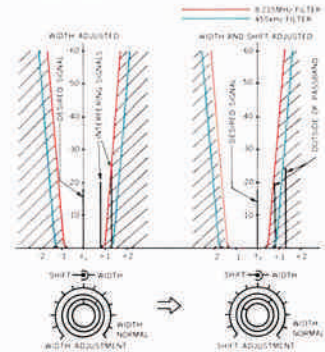

in three 6-dB steps (to coincide with S-units). Typical measured two-tone dynamic range is 108 dB (+32 dBm 3rd-order IP) with the RF amplifier off, and a noise floor of  $-138$  dB with it on (50 kHz spacing at 14.260 MHz, 500-Hz BW, CW mode with no attenuation).

### Simultaneous Dual (Unlimited) Frequency Reception

Dual receiver front-ends, IF strips and vfos allow simultaneous reception and display of two different frequencies,

even in different modes and with different IF bandwidths. A single RX MIX control allows adjusting the relative volume of each channel without having to twiddle multiple knobs. Unique to the FT-1000, each vfo has its own flywheel-weighted tuning knob, requiring no confusing pushbutton selections to tune either frequency. The audio of each vfo can be monitored mixed or split between each ear (with headphones or external stereo amp). Also unlike any other radio, the eleven additional filters in the BPF-1 Sub-Vfo Bandpass Filter option allow the two frequencies to be up to 29.9 MHz apart (using a second antenna). For example, you can monitor WWV on 10 MHz while simultaneously working SSB or CW on 28 MHz, and freely tune either or both frequencies without pushing a single button. (Without the BPF-1 option the main and sub vfos must share the same antenna and bandpass filter.) Note that with or without the BPF-1, a separate receiving antenna can be connected and selected from the front panel—important for serious 160 m operation.

### Dual Receiver Front Ends and IFs

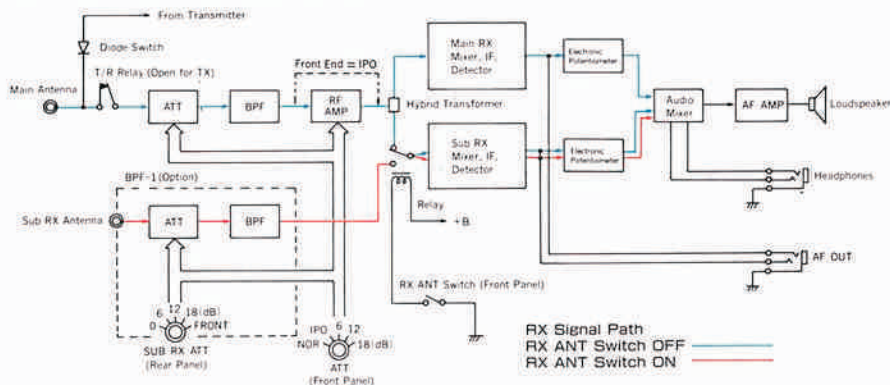

### RF Notch Characteristic

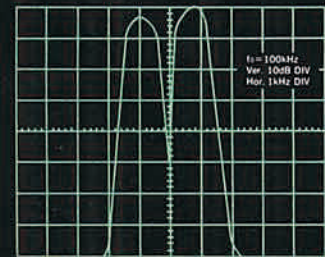

### APF Characteristic

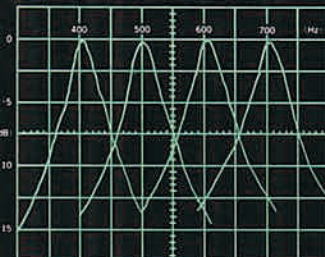

## Optimized Digital Communications Modes

Special provisions for RTTY/AMTOR and packet modes include an independent built-in microprocessor to control AFSK generation for RTTY/AMTOR, providing selectable 2125- or 1275-Hz Mark tones and 170-, 425- and 850-Hz shifts, with upper or lower shift selectable with RTTY mode button. The display can show the Mark frequency, or be loaded with any desired offset. The 500-Hz BW crystal filters can be selected for RTTY, AMTOR and 300-baud packet, and IF offset can be selected from four standard settings matching most popular tones, so that received signals are centered in the IF and the display shows the actual center frequency of the two transmitted tones. Of course any non-standard tone pair/shift can also be accommodated with manual IF shift and independent display offset adjustment (from the front panel). The PACKET mode button selects LSB, or FM (with 1000-Hz shift). A separate RTTY terminal unit and tnc can both be connected independently at the rear panel. FAX and SSTV can also be used in SSB modes.

## Flexible Mode and IF Filter Selection

Each receiver IF (Main and Sub) has its own vfo on each of the ten bands, and each of these vfos has two subband channels per band. Each of these forty tunable vfo channels plus the 99 knob-selectable tunable memories have independently selectable modes and receiving IF filters. For the main receiver, four crystal filters are provided as standard in the 8.2 MHz 2nd IF, and two in the 455-kHz 3rd IF, providing bandwidths of 250 and 500 Hz, and 2.0, 2.4 and 6 kHz with four optional filters

### IF Filtering

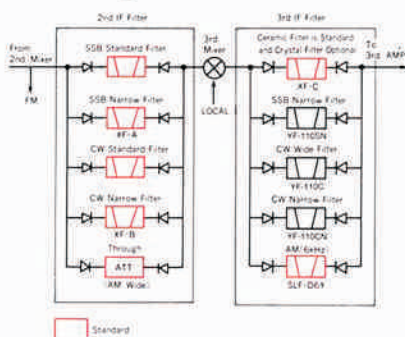

available for the main 455-kHz IF. In addition, the sub receiver comes with a 2.4-kHz BW filter in the 7.68-MHz 2nd IF and another 2.4-kHz filter in the 455-kHz 3rd IF, with a 3rd IF 600-Hz narrow filter available as an option. Selecting filters does not affect the receiving frequency, so, for example, you can switch bandwidths from 2.4 kHz to 500 Hz during a CW QSO without retuning.

## Up to 200 Watts Transmitter Output

While other transceivers offer maximum output of 100 or 150 watts, the FT-1000 gives you clean, continuously adjustable output from 20 to a full 200 watts (50 watts AM carrier), for that extra edge needed in pileups, or to easily drive big linears to the legal limit. The clean DDS-derived local signals combined with 30-volt Vcc to the (MRF422) final transistors results in a typical transmitter 3rd-order IMD of -36 dB (at 150W PEP). An extended transmit duty cycle of 30 minutes cool, quiet keydown full power (@ 100W) results from employing a 10-inch wide squirrel cage blower (instead of the usual fan) and internal interlaced heatsinks. A separate RF PWR (ALC threshold) control allows full adjustment of power output in all modes, and a transmitter RF (not IF) monitor lets you hear just what you're sending to the antenna. The built-in quick-response antenna tuner matches SWRs

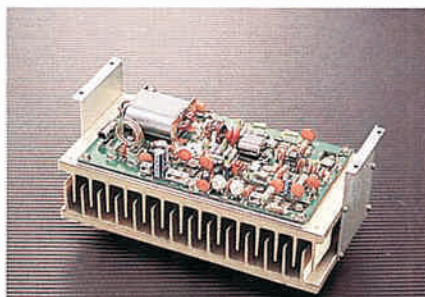

TX PA with Interlaced Heatsinks

### Transmitter IMD Products

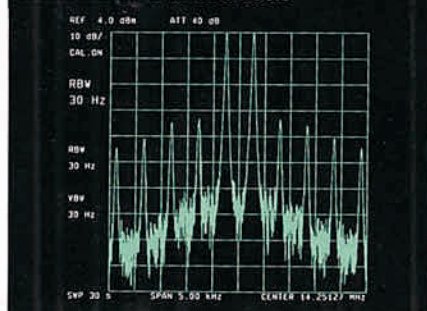

up to 3:1 on the amateur bands, and includes 39 tuner-setting memories for instant recall of previously stored settings. The antenna tuner controls are also accessible by external computer via the CAT System.

## Special Features for CW Operation

Along with the wide array of IF filters and the tunable audio peak filter, the FT-1000 provides selectable bfo offsets of 400-, 500-, 600- and 700-Hz pitch, with matching CW spotting oscillator (to zero-beat your transmitter while receiving) and transmit sidetone. A novel PLL-controlled visual spotting indicator is also provided to facilitate spotting. In addition to front panel speed control, the built-in electronic squeeze keyer includes 15-step weight selection from 1:3 to 1:4.5 dot/dash ratios. Key jacks are provided on both front and rear panels. The CW carrier is injected at the USB side of the IF center frequency, so you can switch between CW and USB without retuning.



Front Panel (Key jack & Keyer Controls)



## Enhanced Integration = Simplified Control

To ensure simple operator control, an 8-bit HD64180 master cpu works in concert with five supporting microprocessors to manage the frequency synthesis and complex functions of the FT-1000. "Shifted" key functions have been eliminated, except for numeric frequency entry on the keypad, which



otherwise provides one-touch instant band selection. Separate buttons are provided for all other significant functions including vfo, mode, and IF and audio filter selection. A detented rotary selector is used for the 99 memories, which can be independently tuned or have their mode or IF filter selection changed directly, just like a vfo. The Clarifier (receive/transmit offset) can be adjusted and is displayed and stored independently of the operating frequency, being added to the main display when either the transmit or receive clarifier is activated. Clearing either clarifier retains the offset on its separate display for instant reuse. The CAT (Computer-Aided Transceiver) System in the FT-1000 is a superset of

the FT-747GX CAT System, allowing control of major functions from an external personal computer. Most existing CAT control programs for the FT-747GX can be used with only slight modification (for example, to make use of the FT-1000's IF filter selections).

### DVS-2 Digital Voice Recording Option

Designed especially for serious DXing and contesting, the DVS-2 option can be used to store receiver audio continuously. Pressing the STOP button saves the last 16 seconds of audio in digital memory, which can then be played back through the transceiver's loudspeaker or earphones (repeatedly, if

desired). In its transmitting mode, for contest or DX calls, the DVS-2 can record either two 8-second messages or four 4-second messages via the microphone, and then play back selected messages on the air at the touch of a button.



**DVS-2**

# FRONT PANEL CONTROLS



1 The main power switch – also performs power-on self test system diagnostics for the digital circuitry.

2 Selects a separate receive-only antenna. LED indicates when selected.

3 Manual (MOX) and voice-actuated (VOX) transmit / receive switching.

4 Display dimmer switch, with adjustable dim intensity to match lighting conditions in your shack.

5 Function selector for transmit parameter indication on the meter.

6 Four-position receiver AGC selector.

7 Receiver RF preamp / attenuator selector. Attenuator steps correspond with S-units, so you can give accurate signal reports without fiddling with the attenuator setting. The IPO position of this switch provides direct feed to the mixer.

8 Receiver audio mixer (balance) control for dual receive operation, and transmitter RF monitor level control.

9 Microphone gain control for SSB and AM modes (FM mic gain is separate, in the top panel), and all-mode transmitter power control

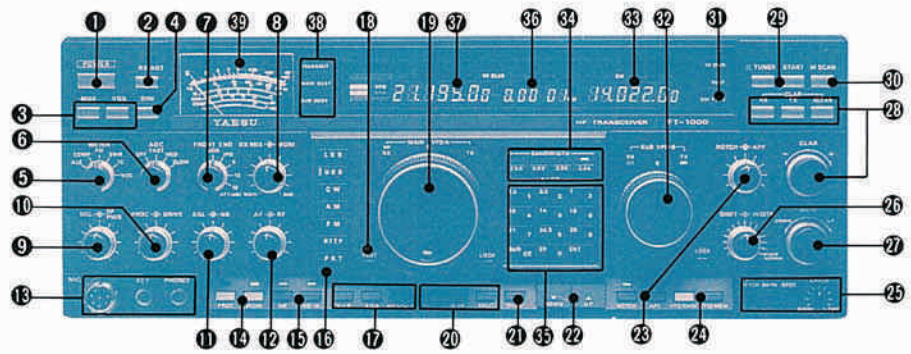

(ALC threshold adjustment.)

10 RF speech processor compression control for SSB, and transmitter drive level control for CW, AM and FM.

11 All-mode squelch threshold controls for scanning, and noise blanker AGC level (for both wide- and narrow-pulse blankers).

12 Receiver audio and RF gain controls for both main and sub receivers.

13 Front panel jacks include microphone scanning lines, one of two CW key jacks, and monaural / stereo headphones jack.

14 RF speech processor and transmitter RF mon-

itor switches with LED indicators.

15 Both wide- and narrow-pulse noise blanker switches with LED indicators.

16 Mode selection by separate switches, each with embedded LED indicator, keeps mode selection simple. The RTTY and PKT selections also cause the USB or LSB indicator (or FM indicator for F2 packet) to light, with the alternate selected by pressing the same button again.

17 Separate switches for vfo selection, swapping and transfer from memory.

18 Fast tuning switch also allows changing the offset of the displayed frequency from the car-



- rier frequency, for custom requirements and preferences.
- 19 Large, flywheel-weighted tuning knob with finger hole and rubber grip.
  - 20 Make convenient use of 10-meter hf repeaters, with 100-kHz repeater offset independent of the multiple vfos and memories. True split operation between main and sub vfos is also available, with four LEDs above the tuning knobs indicating which vfo is selected for transmit and receive. A manual memory check button allows checking the contents of memories while receiving on one of them, without interruption.
  - 21 Activate dual receive operation on both vfos simultaneously.
  - 22 Step the main vfo frequency up or down in 100-kHz or 1-MHz steps.
  - 23 IF notch and audio peak filter (for CW), with LED indicators.
  - 24 Yellow memory write button and vfo / memory selection button.
  - 25 Electronic keyer switch / indicator, full breakin and CW spot switches, with recessible keyer speed control.
  - 26 Concentric IF shift and width controls for all modes (exc. FM) make all IF passband adjustments a simple two-finger operation.
  - 27 Detented selector for the 99 memories. Turning this knob while operating on a vfo activates memory checking mode temporarily, to display contents of memories without disturbing operation.
  - 28 Clarifier offset control functions independently of vfo tuning knobs, to set actual offset shown by itself at the center of the display (in addition to changing the vfo display), for either receive, transmit or both. Hit the clear button to cancel the offset.
  - 29 A new, quick automatic antenna tuner with 39 memories of its own, for nearly instant recall of previously used settings. Tuner status LEDs indicate current state of antenna matching function.
  - 30 Memory scanning button, to scan preselected memories.
  - 31 Visual CW spotting indicator lights in concert with the received signal nearest the center of the passband.
  - 32 Independent, heavy flywheel weighted sub vfo tuning knob allows tuning sub vfo without fumbling with vfo switching – a must for serious dual-receive operation. Separate receive / transmit function indicators and lock button are provided for the sub vfo.
  - 33 Independent mode and frequency display for the sub vfo.
  - 34 Four separate IF bandwidth selection buttons and LED indicators let you select any practical bandwidth independently of operating mode, with your selection retained in the vfo or memory.
  - 35 Twelve separate band-selection keys let you select any ham band with a single keystroke, or key in any frequency digitally by first pressing the ENT key.
  - 36 Current clarifier offset and memory channel number.
  - 37 Main vfo or current memory frequency, with status indicators for dual receive, split, general coverage, (out-of-ham-band) operation, external CAT control, and miscellaneous functions.
  - 38 Transmit and squelch status indicator LEDs.
  - 39 Six-Function multimeter for transmitter parameters, and S-meter for receiver.

## CONTROLS WITH TOP PANEL ACCESS

- 1 CW Pitch switches select your preferred CW bfo offset: 400, 500, 600 or 700 Hz.
- 2 Memory backup slide switch to clear memories.

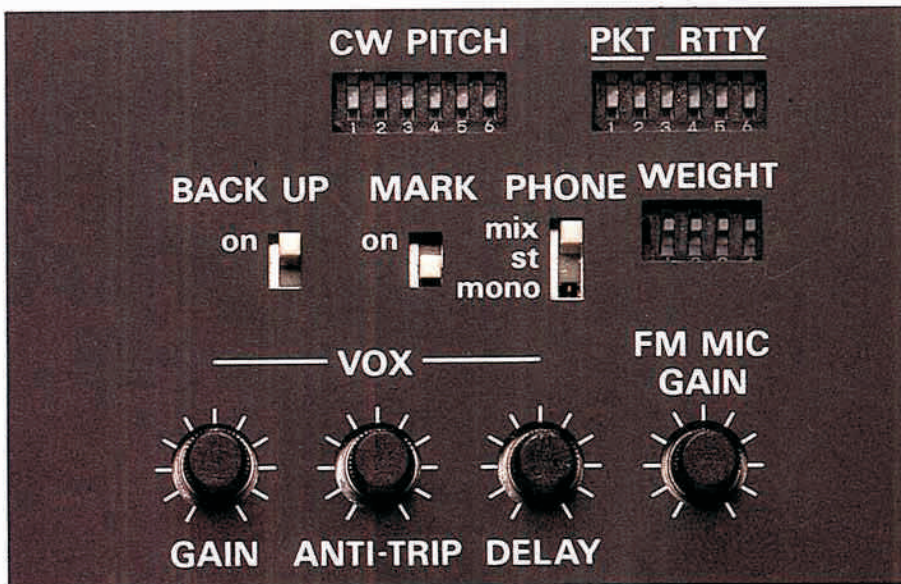

- 3 25 kHz marker generator switch to confirm calibration.
- 4 Dual audio output mode switch: selects whether dual-receive audio should be mixed or separate in each stereo channel, or monaural.
- 5 VOX gain, anti-trip and delay controls.
- 6 Independent microphone gain control for FM (sets maximum deviation).

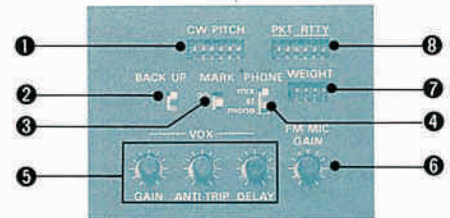

- 7 CW dot/dash weighting selection for the internal electronic keyer, from 1:3 to 1:4.5.
- 8 IF/display offset selection for F1 packet: 1170, 1700, 2125 or 2210 Hz (with others available manually), and Mark tone and shift frequency selection for internal FSK generator for RTTY/AMTOR: 1275- or 2125-Hz Mark tones, and 170-, 425- or 850-Hz shifts.

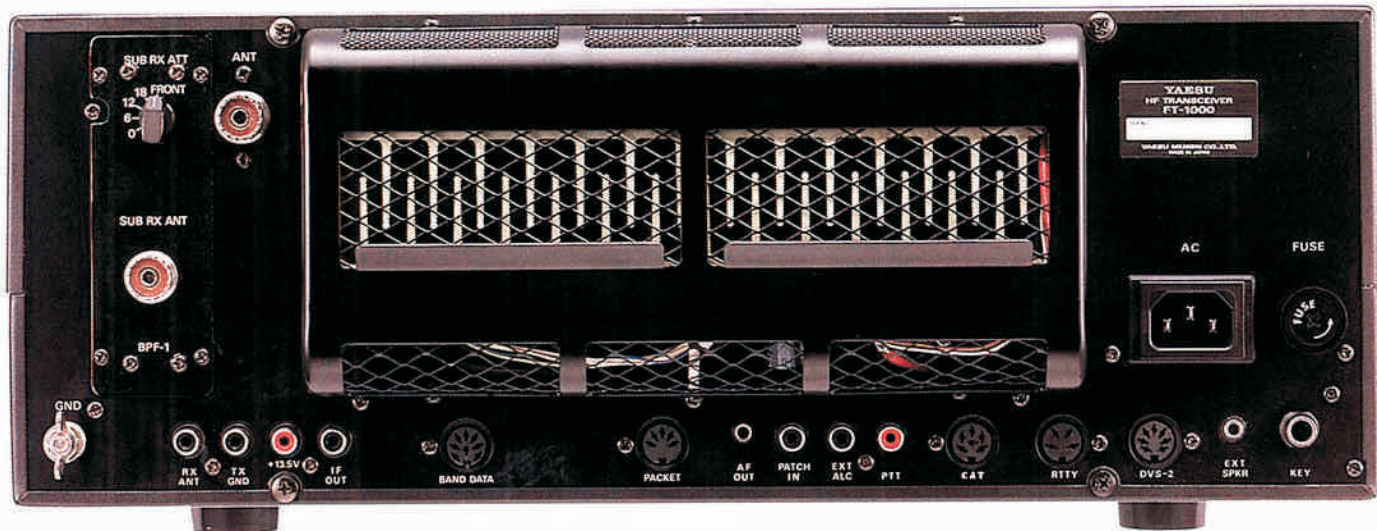

## REAR PANEL

- 1 BPF-1 optional sub vfo bandpass filter unit, with RF attenuator selector (allows independent settings, or shared settings with main vfo on front panel); and sub vfo receiving antenna jack.
- 2 Grounding terminal.
- 3 Receive-only antenna jack, selected by RX ANT button on front panel.
- 4 T/R relay contact access (ground on transmit) for linear amplifier switching.
- 5 +13.5V DC source for tnc / terminal units.
- 6 Buffered output of the 73.62-MHz 1st IF, for a monitor scope.
- 7 Band selection control output lines for automatic linear amplifiers such as the VL-1000.

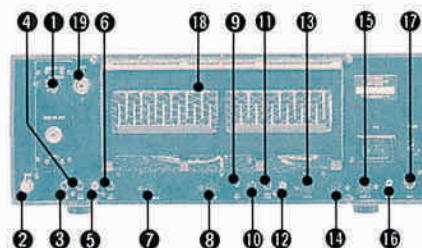

- 8 Connect the RADIO jack of your packet tnc here.
- 9 Stereo audio output jack for an external audio amplifier.
- 10 Phone patch audio input (mixed with microphone input)
- 11 External transmitter ALC input from a linear amplifier, to control drive level when used as an exciter.

- 12 External PTT input for a foot switch or other t / r-switching device.
- 13 CAT (computer-aided transceiver) interface, for external control by a personal computer through a TTL / RS-232C converter such as the FIF-232C. Includes digitized meter level.
- 14 RTTY terminal unit connector (includes FSK input).
- 15 DVS-2 Digital Voice Synthesizer (option) jack.
- 16 External loudspeaker jack.
- 17 One of two parallel-connected CW key jacks (the other is on the front panel). Either a straight key or paddles may be connected to either or both jacks.
- 18 Dual interlaced heatsinks with squirrel cage blower inside allows up to 200 watts output.
- 19 Main antenna jack, also used by sub receiver if BPF-1 is not installed.



## OPTIONS

### BPF-1 Bandpass Filter Module

Consisting of 11 receiver bandpass filters and its own switchable attenuator network, the BPF-1 allows the sub receiver in the FT-1000 to be tuned to any frequency independently from the main receiver (separate antenna required). The attenuator control on the BPF-1 can be used independently from the FT-1000 front panel attenuator knob, if desired.

### TCXO-1 Temperature-Compensated Crystal Oscillator

For special applications and environments where extra frequency stability is essential, such as for long-term HF packet monitoring under wide temperature variations, the TCXO-1 provides  $\pm 0.5$  ppm stability from  $-10^{\circ}$  to  $+60^{\circ}\text{C}$  for the master oscillator.

### MD-100A8X Desk-Top Microphone

Providing excellent audio response for a wide variety of operating situations, the MD-100A8X includes an up/down scanning control, along with both manual and latching PTT switches. Its 600- $\Omega$  impedance and cosmetics are the perfect match for your FT-1000.



BPF-1

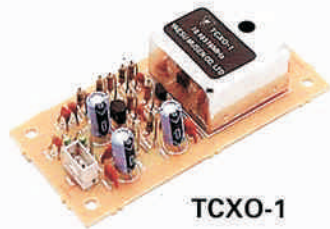

TCXO-1



MD-100A8X

### SP-5 Loudspeaker with Audio Filters and LL-5 Phone Patch Option

Selectable audio high- and low-pass filters together with a large loudspeaker complement the superb audio characteristics of the FT-1000 with your choice of 12 different audio filtering selections.

Two input terminals are provided for multiple transceivers, with a front panel switch to select between them. A phone jack is provided on the front panel to take advantage of the audio filters with headphones.

With the optional LL-5 Phone Patch Unit installed in the SP-5, the FT-1000 can be patched to the public telephone network. The LL-5 includes a hybrid transformer circuit to assure proper impedance matching, plus front panel gain controls and level meter to set proper audio levels on the phone line.

### YH-77STA Lightweight Stereo Headphones

Dual samarium-cobalt transducers with sensitivity of 103 dB/mW ( $\pm 2\text{dB}$ , @1kHz, 35  $\Omega$ ) provide the perfect match for the FT-1000. During dual receive with the YH-77STA one receiver can be monitored in each ear,



SP-5

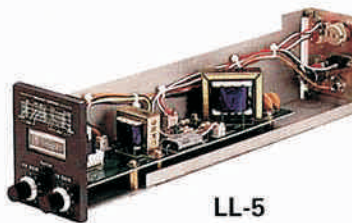

LL-5

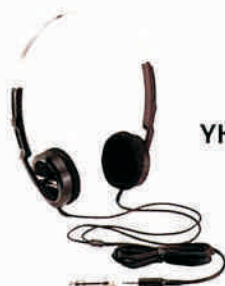

YH-77STA

allowing easy separation of the signals from the two receivers (or the audio can be mixed, if desired).

### DVS-2 Digital Voice System

Serving as either a continuous receiver recorder for instant pushbutton playback, or microphone audio recorder for multiple on air playback, the DVS-2 applies the advantages of random-access solid-state digital memory to serious communications. All data is stored electronically, with no moving parts except your finger and the pushbutton.

### IF Crystal Filter Options

Five crystal filters are available for the FT-1000, allowing cascading of selectivity in the 3<sup>rd</sup> IF or improved interference rejection in the sub receiver (XF-455MC). The main receiver's 2<sup>nd</sup> IF includes factory-installed filters for 6 kHz, 500 Hz, and 250 Hz.

### XF-C

Main receiver, 2.4 kHz BW, 3<sup>rd</sup> IF (Supplied in FT-1000D)

### YF-110SN

Main receiver, 2.0 kHz BW, 3<sup>rd</sup> IF (Supplied in FT-1000D)

### YF-110C

Main receiver, 500 Hz BW, 3<sup>rd</sup> IF (Supplied in FT-1000D)

### YF-110CN

Main receiver, 250 Hz BW, 3<sup>rd</sup> IF (Supplied in FT-1000D)

### XF-455MC

Sub receiver, 600 Hz BW (CW)



IF Crystal Filter



DVS-2

# SPECIFICATIONS

Receiving frequency range: 100 kHz—30 MHz

Transmitting frequency ranges:

160 m band, 1.5 — 2.0 MHz

80 m band, 3.5 — 4.0 MHz

40 m band, 7.0 — 7.5 MHz

30 m band, 10.0 — 10.5 MHz

20 m band, 14.0 — 14.5 MHz

17 m band, 18.0 — 18.5 MHz

15 m band, 21.0 — 21.5 MHz

12 m band, 24.5 — 25.0 MHz

10 m band, 28.0 — 29.7 MHz

Frequency accuracy:

(except FM,  $< \pm 100$  Hz),

$< \pm 0.5$  ppm at room temperature

Frequency stability:  $< \pm 2$  ppm from 0 to  $+50^\circ\text{C}$

(except FM,  $< \pm 200$  Hz),

$< \pm 0.5$  ppm from  $-10$  to  $+60^\circ\text{C}$  w/TCXO-1 option

(FM  $< \pm 150$  Hz from 0 to  $+50^\circ\text{C}$ )

Emission modes: LSB/USB (J3E), CW (A1A),

FSK (J1D, J2D), AM (A3E), FM (F3E)

Basic frequency steps:

10 Hz for J3E, A1A and J1D;

100 Hz for A3E, F3E and J2D

Antenna impedance:

16.5 to  $150\ \Omega$ ,  $50\ \Omega$  nominal

Supply voltage:

100, 110, 117, 200, 220 or 234 VAC, 50/60 Hz

Power consumption (approx.):

95 VA receive, 1050 VA for 200 watts transmit

Dimensions (WHD): 420 x 150 x 375 mm

Weight (approx.): 25.5 kg (51 lbs)

## TRANSMITTER

Power output:

adjustable up to 200 watts (50 watts AM carrier)

Duty cycle: 100% @ 100 watts,

50% @ 200 watts (FM & RTTY, 3-minute tx)

Modulation types

SSB: Balanced, filtered carrier

AM: Low-level (early stage)

FM: Variable reactance

FSK: Audio frequency shift keying

Maximum FM deviation:  $\pm 2.5$  kHz

FSK shift frequencies: 170, 425 and 850 Hz

Packet shift frequencies: 200, 1000 Hz

Harmonic radiation:

at least 50 dB below peak output

SSB carrier suppression:

at least 40 dB below peak output



Undesired sideband suppression:  
 at least 50 dB below peak output  
 Audio response (SSB):  
 not more than -6 dB from 400 to 2600 Hz  
 3rd-order IMD: -36 dB @ 150 watts PEP,  
 -31 dB @ 200 watts PEP, or better  
 Microphone impedance: 500 to 600 Ω

## RECEIVER

Circuit type:  
 quad-conversion superheterodyne  
 (triple conversion for FM)  
 Intermediate frequencies:  
 73.62 and 8.215 MHz, and 455 and 100 kHz  
 Sensitivity:  
 With preamp on, for 10 dB S/N, 0 dBμ = 1 μV

Frequency ⇒ Mode (BW) ↓	100 – 250 kHz	250 – 500 kHz	0.5 – 1.8 MHz	1.8 – 30 MHz
SSB, CW (2.4 kHz)	< 1.25 μV	< 1 μV	< 2 μV	< 0.25 μV
AM (6 kHz)	< 10 μV	< 8 μV	< 16 μV	< 1 μV
29 MHz FM (for 12 dB SINAD)	—	—	—	< 0.5 μV

Selectivity (-6/-60 dB):

Button	Modes	Minimum -6 dB BW	Maximum 60 dB BW
2.4 kHz	all exc. FM	2.2 kHz	3.8 kHz
2.0 kHz	all exc. AM, FM	1.8 kHz	3.6 kHz
500 Hz	CW, RTTY, Packet	500 Hz	1.2 kHz
250 Hz	CW, RTTY	240 Hz	700 Hz
—	AM (wide)	6 kHz	14 kHz

Dynamic range (typical):  
 108 dB (@50 kHz, 500 Hz BW, RF amp off)  
 Squelch sensitivity:  
 1.8—30 MHz (CW, SSB, AM): < 2.0 μV  
 28—30 MHz (FM): < 0.32 μV  
 IF rejection (1.8—30 MHz): 80 dB or better  
 Image rejection (1.8—30 MHz): 80 dB or better  
 IF shift range: ±1.12 kHz  
 Maximum audio power output:  
 2 watts into 4Ω with < 10% THD  
 Audio output impedance: 4 to 8Ω

*Specifications are subject to change, in the interest of technical improvement, without notice or obligation.*



**YAESU MUSEN CO., LTD.**

4-8-8 Nakameguro, Meguro-ku, Tokyo 153-8644, Japan

**YAESU U.S.A.**

17210 Edwards Rd., Cerritos, CA 90703, U.S.A.

**YAESU EUROPE B.V.**

P.O. Box 75525, 1118 ZN Schiphol, The Netherlands

**YAESU UK LTD.**

Unit 12, Sun Valley Business Park, Winnall Close  
Winchester, Hampshire, SO23 0LB, U.K.

**YAESU GERMANY GmbH**

Am Kronberger Hang 2, D-65824 Schwalbach, Germany

**YAESU HK LTD.**

11th Floor Tsim Sha Tsui Centre, 66 Mody Rd.,  
Tsim Sha Tsui East, Kowloon, Hong Kong